



C8MPV Product Specifications

80+ Variable Speed Two-Stage Heating Furnace

FLEXIBILITY

- Supports two-stage cooling units
- 40" (1016mm) high, for ease of installation
- Factory shipped for natural gas, with Propane gas conversion kits available
- Four position - upflow/downflow/horizontal installation
- Three position inducer capability
- Category I venting
- Common venting with other Category I appliances

SERVICE

- Self diagnostics
- Entire blower assembly removable

COMFORT

- Adjustable timed blower heating Off delay
- Adjustable timed blower cooling On/Off delay
- 24 and 115 VAC humidifier terminals
- Electronic air cleaner terminal

EFFICIENCY

- 80% AFUE
- Two-stage operation
- BPM Variable speed DC motor
- Two-stage Induced draft blower
- In-shot burners
- California NOx approved

QUALITY

- RPJ3 Aluminized steel heat exchanger
- High temperature limit control prevents overheating
- Direct ignition with Silicon Nitride ignitor
- Flame roll-out sensors standard
- Louvered doors
- One piece prepainted steel cabinet
- Masonry chimney adapter available (Some models)

WARRANTY *

- 10 year No Hassle Replacement™ limited warranty
 - 25 year heat exchanger limited warranty with timely registration
 - 5 year parts limited warranty
 - With timely registration, an additional 5 year parts limited warranty
- * Applies to original purchaser/homeowner, some limitations may apply. See warranty certificate for complete details.



Illustrations and photographs are only representative. Some product models may vary.

⚠ WARNING

This furnace is not designed for use in mobile homes, trailers, or recreational vehicles. Such use could result in property damage and/or death.

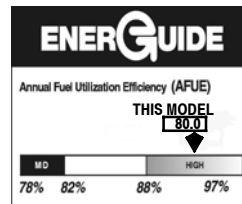

UPFLOW/DOWNFLOW/HORIZONTAL (NATURAL GAS)							
Model Number	Dimensions H x W x D		Input (MBTUH)	Efficiency AFUE	Cooling Capacity @ .5 in wc (125 Pa)	Shipping Wt.	
	Inches	Millimeters				Lbs	Kg
C8MPV050B12C	40 x 15 ¹ / ₂ x 29	1016 x 394 x 737	50,000	80%	1.5 - 3.0 TON	130	59
C8MPV075F14C	40 x 19 ¹ / ₈ x 29	1016 x 486 x 737	75,000	80%	1.5 - 3.5 TON	154	70
C8MPV100J20C	40 x 22 ³ / ₄ x 29	1016 x 578 x 737	100,000	80%	2.5 - 5.0 TON	174	79
C8MPV125J20C	40 x 22 ³ / ₄ x 29	1016 x 578 x 737	125,000	80%	3.0 - 5.0 TON	176	80

FURNACE SPECIFICATIONS MULTI-POSITION

Model Number		NATURAL GAS	*8MPV050B12C	*8MPV075F14C	*8MPV100J20C	*8MPV125J20C
INPUT (btuh)	HI Heat		50,000	75,000	100,000	125,000
	LO Heat		35,000	52,500	70,000	87,500
HTG. CAP. (btuh)	HI Heat		40,000	61,000	81,000	101,000
	LO Heat		28,000	42,000	61,000	71,000
AFUE % (ICS)			80.0%	80.0%	80.0%	80.0%
NOx (Ng/L)			<40			
TEMP. RISE (DEGREES)	HI Heat (°F/°C)		30-60/17-33	30-60/17-33	35-65/19-36	30-60/17-33
	LO Heat (°F/°C)		25-55/14-30	25-55/14-30	35-65/19-36	25-55/14-30
VOLTS/PH/Hz			115/60/1			
MIN./MAX. VOLTAGE			104/127			
RATING PLATE AMPS.			9.8	11.7	14.9	14.9
TRANSFORMER (V.A.)			40			
GAS PIPE SIZE - in.(mm)			1/2 (12.7)			
FLUE COLLAR SIZE - in.(mm)			4 (101.6mm)			
COOLING CAP.			3.0 TON	3.5 TON	5.0 TON	5.0 TON
FILTER SIZE required - in.(mm) (qty)			14 x 25 x 1 (356 x 635 x 25)		16 x 25 x 1 (406 x 635 x 25) (2)	
DIMENSIONS H x W x D - in.(mm)			40 x 15 ¹ / ₂ x 28 ¹ / ₂ (1016 x 394 x 724)	40 x 19 ¹ / ₈ x 28 ¹ / ₂ (1016 x 486 x 724)	40 x 22 ³ / ₄ x 28 ¹ / ₂ (1016 x 578 x 724)	
SHIPPING WEIGHT - Lbs(Kg)			130 (59)	154 (70)	174 (79)	176 (80)

ACCESSORIES

Model Number	Description	Used With Models
GAS CONVERSION KITS		
NAHA002LP 1172959**	Natural gas to Propane conversion Kit. Allows field conversion to Propane gas.	ALL *8MPV FURNACES
NAHA002NG 1172961**	Propane to natural gas conversion kit. Allows field conversion to natural gas.	ALL *8MPV FURNACES
VARIABLE SPEED BLOWER UPGRADE KIT		
NAHA050VBE	Blower Upgrade Kit for B Series furnace only - Variable speed blower upgrade conversion to a two stage cooling compatible variable speed motor (consists of blower motor and electronics for two stage furnaces ONLY)	*8MPV050
NAHA075VBE		*8MPV075
NAHA100VBE		*8MPV100
NAHA125VBE		*8MPV125
FILTER KITS		
NAHA001FF	Filter Kits - External filter frame. 16" x 25" (406mm x 635mm)	Side Return (All Furnaces) Bottom Return (All "F" 19 ¹ / ₈ " Furnaces under 1600 CFM)
NAHA001FP	External filter frame. 16" x 25" (406mm x 635mm) Bulk Pack Kit - Qty 10	
NAHA002FF	Filter Kits - Bottom return filter frame kit 20" x 25" (508mm x 635mm)	All "J" 22 ³ / ₄ " Furnaces
NAHA002FP	Bottom return filter frame kit 20" x 25" (508mm x 635mm) Bulk Pack Kit - Qty 10	
NAHA003FF	Bottom or side return filter frame kit 14" x 25" (356mm x 635mm)	All "B" 15 ¹ / ₂ " Furnaces
NAHA003FP	Bottom return filter frame kit 14" x 25" (356mm x 635mm) Bulk Pack Kit - Qty 10	
NAHA001TK	Duct Standoff Filter Kit. To adapt 20" x 25" (508mm x 635mm) filter for single side return.	Side Return (All single return applications with 1600 CFM or greater) Bottom Return (All "F" 19 ¹ / ₈ " Furnaces under 1600 CFM)
COMBUSTIBLE FLOOR SUBBASES		
NAHH001SB	Subbase Furnace ONLY: All 15 ¹ / ₂ " wide furnace models	*8MPV050B
NAHH002SB	Subbase Furnace ONLY: All 19 ¹ / ₄ " wide furnace models	*8MPV075F-100F
NAHH003SB	Subbase Furnace ONLY: All 22 ³ / ₄ " wide furnace models	*8MPV100J-125J
NAHH004SB	Subbase Furnace w/ 15 ¹ / ₂ " cased coil	Counterflow furnace *8MPV050B
NAHH005SB	Subbase Furnace w/ 19 ¹ / ₄ " cased coil	Counterflow furnace *8MPV075F-100F
NAHH006SB	Subbase Furnace w/ 22 ³ / ₄ " cased coil	Counterflow furnace *8MPV100J-125J
MASONRY CHIMNEY ADAPTER		
NAHA001DH	Chimney adapter 6"(152mm)	*8MPV075, 100
NAHA002DH	Chimney adapter 7"(178mm)	*8MPV125
VENT GUARD		
NAHA002VC	Downflow vent guard	All Furnaces in the Downflow Application
COIL ADAPTER		
NAHA001CA	Coil Adapter for Downflow Furnaces	All Furnaces in the Downflow Application
WARNING LABEL REPLACEMENT KIT		
NAHA002WL	To replace Warning Labels, Operating Instructions & Wiring Labels on Blower Door when needed	*8MPV

* Denotes Brand (C, H, T)

** Must be ordered from Service Parts

UNIT DIMENSIONS

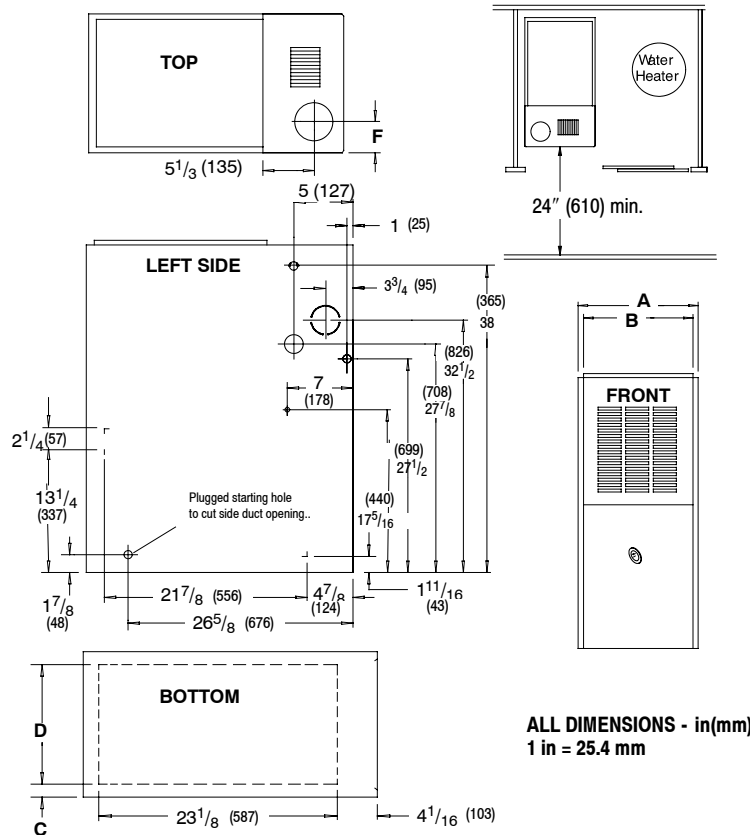

ALL DIMENSIONS - in(mm)
1 in = 25.4 mm

Furnace Capacity	Cabinet		Top	Bottom		Return Air Opening
	A	B	F	C	D	
*8MPV050B12	15 1/2 (394)	14 (356)	6 (152)	1 3/8 (35)	12 5/8 (321)	H
*8MPV075F14	19 1/8 (486)	17 1/2 (445)	7 3/4 (197)	2 1/8 (54)	14 3/4 (375)	J
*8MPV100J20	22 3/4 (578)	21 1/4 (540)	9 1/2 (241)	1 15/16 (49)	18 3/4 (476)	J
*8MPV125J20	22 3/4 (578)	21 1/4 (540)	9 1/2 (241)	1 15/16 (49)	18 3/4 (476)	J

* Denotes Brand

Drawing is representative, but some models may vary

MINIMUM CLEARANCES TO COMBUSTIBLE MATERIALS FOR ALL UNITS	
REAR	0
FRONT (combustion air openings in furnace and in structure)	3" (76 mm)
Required For Service	*24" (610 mm)
ALL SIDES OF SUPPLY PLENUM	1" (25 mm)
SIDES	0
VENT	
Single Wall Vent	6" (152 mm)
Type B-1 Double Wall Vent	1" (25 mm)
TOP OF FURNACE	1" (25 mm)

*30" (762 mm) clearance recommended for furnace removal.

Horizontal position: Line contact is permissible only between lines formed by intersections of top and two sides of furnace jacket, and building joists, studs or framing.

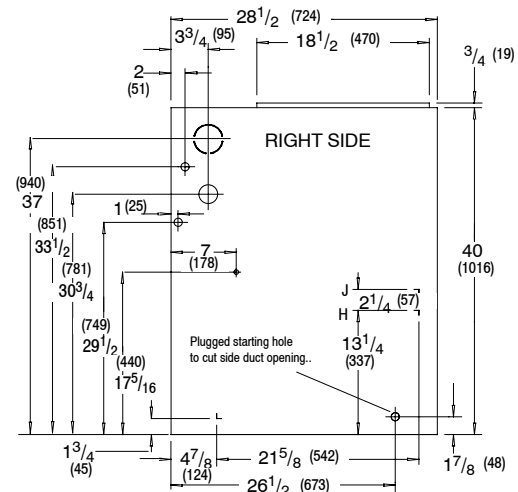

NOTE: Evaporator "A" coil drain pan dimensions may vary from furnace duct opening size. Always consult evaporator specifications for duct size requirements.

Furnace is designed for bottom return or side return. Return air through back of furnace is NOT allowed.

MODEL NUMBER IDENTIFICATION GUIDE

* Brand	8	MP	V	075	B	12	C	#
Brand Efficiency 8 = Non-Condensing, 80+% Gas Furnace 9 = Condensing, 90+% Gas Furnace								Engineering Rev. Denotes minor change
Installation Configuration UP = Upflow DN = Downflow UH = Upflow/Horizontal HZ = Horizontal DH = Downflow/Horizontal MP = Multiposition, Upflow/Downflow/Horizontal								Marketing Digit Denotes major change
Major Design Feature 1 = One (Single) Pipe N = Single Stage 2 = Two Pipe P = PVC Vent D = 1 or 2 Pipe T = Two Stage L = Low NOx V = Variable Speed								Cooling Airflow 08 = 800 CFM 16 = 1600 CFM 12 = 1200 CFM 20 = 2000 CFM 14 = 1400 CFM
								Cabinet Width B = 15.5" Wide J = 22.8" Wide F = 19.1" Wide L = 24.5" Wide
								Input (Nominal MBTUH)

* Denotes Brand (C, H, T)

Circulation Air Blower Data - *8MPV050

Cooling Adjustment					Heating Rise Adjustment			
DIP Switch (OFF = 0 ON = 1)	High Cool @ .50 in wc(125 Pa)		Low Cool (80% of High Cool)		** Adjust Jumper Setting	DIP Switch (OFF = 0 ON = 1)	High Heat Rise Change @ 0.20 in wc (50 Pa)	Low Heat Rise Change at Resultant Static
	5 & 6	CFM	L/s	CFM				
00	1235	583	988	466	+	00	-3	-3
*00	1206	569	965	455	*NOM	*00	0	0
00	1114	526	891	420	-	00	5	4
01	1092	515	874	412	+	01	0	0
01	1021	482	817	386	NOM	01	3	4
01	949	448	759	358	-	01	8	6
10	884	417	707	334	+	10	-2	-1
10	826	390	661	312	NOM	10	2	2
10	740	349	592	279	-	10	6	5
11	650	307	520	245	+	11	-7	-5
11	591	279	473	223	NOM	11	-4	-3
11	530	250	424	200	-	11	0	0

Airflow performance includes 1" washable filter media.

*Factory Setting

**Adjust Jumper Setting (+, NOM, -) is applied to both Cooling and Heating

Note 1: HP Mode Jumper provides a 10% reduction in airflow when in Comfort position and a call for low or high cooling is present with the "O" line off. This feature is to provide lower airflow for running in HP Heating Mode if desirable.

Note 2: DEHUM mode (24VAC on DEHUM terminal) provides a 20% airflow reduction during cooling calls.

Note 3: Low Heat ESP is a result of High Heat ESP (- is decrease in rise).

Note 4: High and low heat rise values are approximate air temperature change from return air temperature when at factory default settings.

Table 2	Airflow	
DIP Switch (OFF = 0 / ON = 1)	Continuous Fan @ 0.10 in wc (25 Pa) ESP	
1 & 2	CFM	L/s
*00	620	293
01	1060	500
10	1333	629
11	1333	629

Table 3	SW2 DIP Assignments
DIP Switch	Blower Parameter
1 & 2	Cont Fan Adj
3 & 4	Heat Speed Adj
5 & 6	Cool Speed Adj
7 & 8	Cool On/Off Delay

* Factory Setting

Table 4	Cooling Delay Options (SW2 - 7, 8)			
	ON DELAY		OFF DELAY	
DIP SW2 - 7/8 (OFF = 0 / ON = 1)	Timed ON (sec)	Airflow during on delay	Timer OFF (sec)	Airflow during off delay
*00	5	OFF	90	100%
01	5	OFF	0	OFF
10	30	50%	30	100%
11	30	50%	180	50%

Airflow % is of High Cool airflow demand determined from SW2-5/6 Table 1

Airflow resumes to 100% after on delay time is completed

Airflow stops (or switches to continuous fan speed) after off delay time is completed

* Factory Setting

MAX CFM (L/s) for Factory Washable Filters	
Filter Size in(mm)	CFM(L/s)
14" X 25" (356 x 635)	1400 (661)
16" X 25" (406 x 635)	1600 (755)
20" X 25" (508 x 635)	2000 (944)
24" X 25" (610 x 635)	2500 (1180)
Max CFM (L/s) based on 600 FPM (3.0 M/s)	

NOTE: Disposable filters are typically rated at 300 FPM (1.5 M/s). These filters only allow half the airflow when compared to 600 FPM (3.0 M/s) filters.

EXAMPLE (approx.):

20in X 25in @ 600 FPM = 2000 CFM, @ 300 FPM = 1000 CFM
508mm x 635mm @ 3.0 M/s = 944 L/s, @ 1.5 M/s = 472 L/s

Circulation Air Blower Data - *8MPV050

Cooling Airflow Settings

High Cooling Airflows *8MPV050B12

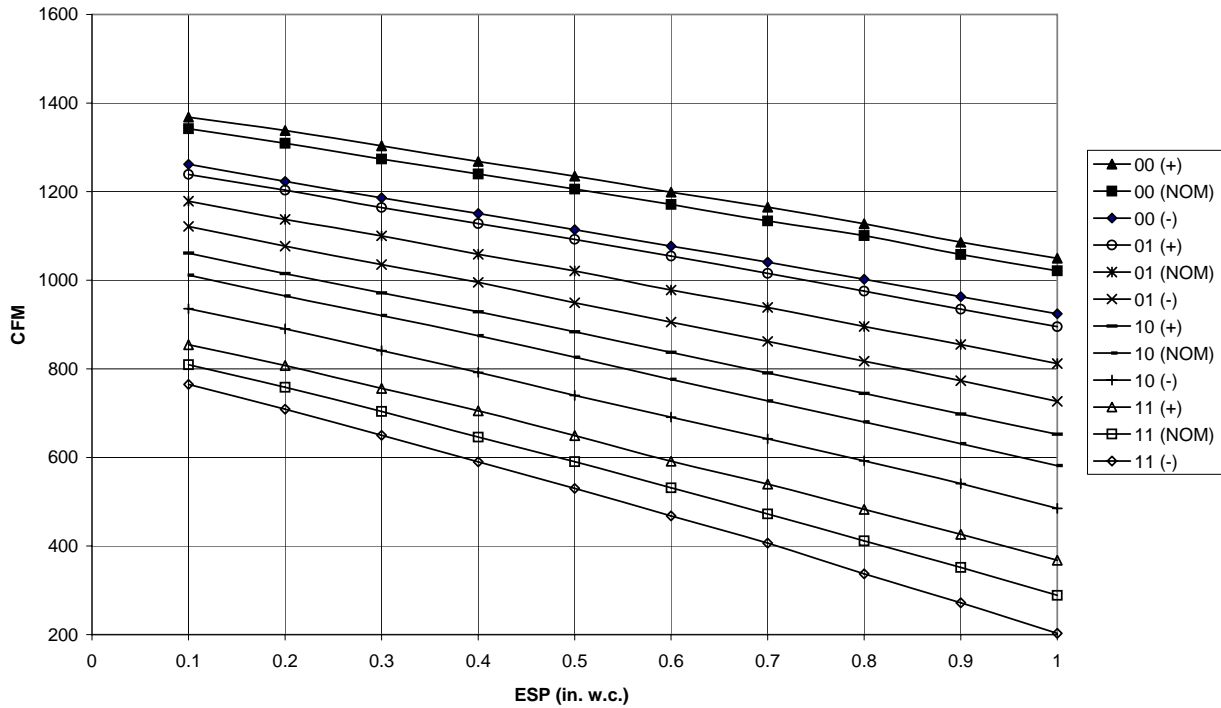

Low Cooling Airflows *8MPV050B12

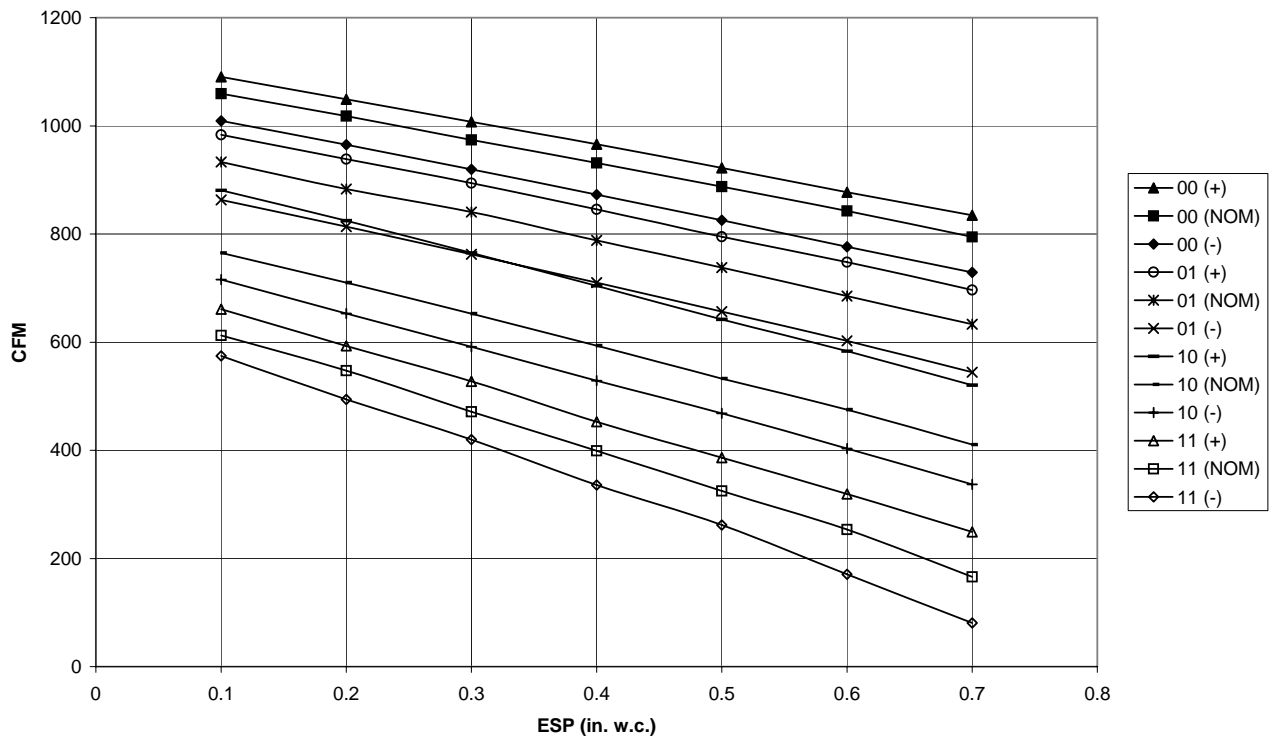

NOTE: OFF = 0 / ON = 1

Circulation Air Blower Data - *8MPV075

Cooling Adjustment					Heating Rise Adjustment			
DIP Switch (OFF = 0 ON = 1)	High Cool @ .50 in wc(125 Pa)		Low Cool (80% of High Cool)		** Adjust Jumper Setting	DIP Switch (OFF = 0 ON = 1)	High Heat Rise Change @ 0.20 in wc (50 Pa)	Low Heat Rise Change at Resultant Static
	5 & 6	CFM	L/s	CFM				
00	1550	731	1240	585	+	00	-3	-2
*00	1423	672	1138	537	*NOM	*00	0	0
00	1240	585	992	468	-	00	3	3
01	1524	719	1219	575	+	01	0	0
01	1209	571	967	456	NOM	01	2	3
01	1038	490	830	392	-	01	7	6
10	1131	534	905	427	+	10	-3	-3
10	1005	474	804	379	NOM	10	0	1
10	851	402	681	321	-	10	3	4
11	908	429	726	343	+	11	-8	-7
11	777	367	622	294	NOM	11	-7	-6
11	651	307	521	246	-	11	-4	-2

Airflow performance includes 1" washable filter media.

* Factory Setting

** Adjust Jumper Setting (+, NOM, -) is applied to both Cooling and Heating

Note 1: HP Mode Jumper provides a 10% reduction in airflow when in Comfort position and a call for low or high cooling is present with the "O" line off. This feature is to provide lower airflow for running in HP Heating Mode if desirable.

Note 2: DEHUM mode (24VAC on DEHUM terminal) provides a 20% airflow reduction during cooling calls.

Note 3: Low Heat ESP is a result of High Heat ESP (- is decrease in rise).

Note 4: High and low heat rise values are approximate air temperature change from return air temperature when at factory default settings.

Table 2	Airflow	
DIP Switch (OFF = 0 / ON = 1)	Continuous Fan @ 0.10 in wc (25 Pa) ESP	
1 & 2	CFM	L/s
*00	700	330
01	1244	587
10	1597	754
11	1597	754

Table 3	SW2 DIP Assignments
DIP Switch	Blower Parameter
1 & 2	Cont Fan Adj
3 & 4	Heat Speed Adj
5 & 6	Cool Speed Adj
7 & 8	Cool On/Off Delay

* Factory Setting

Table 4	Cooling Delay Options (SW2 - 7, 8)				
	DIP SW2 - 7/8 (OFF = 0 / ON = 1)	ON DELAY		OFF DELAY	
		Timed ON (sec)	Airflow during on delay	Timer OFF (sec)	Airflow during off delay
*00	5	OFF	90	100%	
01	5	OFF	0	OFF	
10	30	50%	30	100%	
11	30	50%	180	50%	

Airflow % is of High Cool airflow demand determined from SW2-5/6 Table 1

Airflow resumes to 100% after on delay time is completed

Airflow stops (or switches to continuous fan speed) after off delay time is completed

* Factory Setting

MAX CFM (L/s) for Factory Washable Filters	
Filter Size in(mm)	CFM(L/s)
14" X 25" (356 x 635)	1400 (661)
16" X 25" (406 x 635)	1600 (755)
20" X 25" (508 x 635)	2000 (944)
24" X 25" (610 x 635)	2500 (1180)
Max CFM (L/s) based on 600 FPM (3.0 M/s)	

NOTE: Disposable filters are typically rated at 300 FPM (1.5 M/s). These filters only allow half the airflow when compared to 600 FPM (3.0 M/s) filters.

EXAMPLE (approx.):
20in X 25in @ 600 FPM = 2000 CFM, @ 300 FPM = 1000 CFM
508mm x 635mm @ 3.0 M/s = 944 L/s, @ 1.5 M/s = 472 L/s

Circulation Air Blower Data - *8MPV075

High Cooling Airflows *8MPV075F14

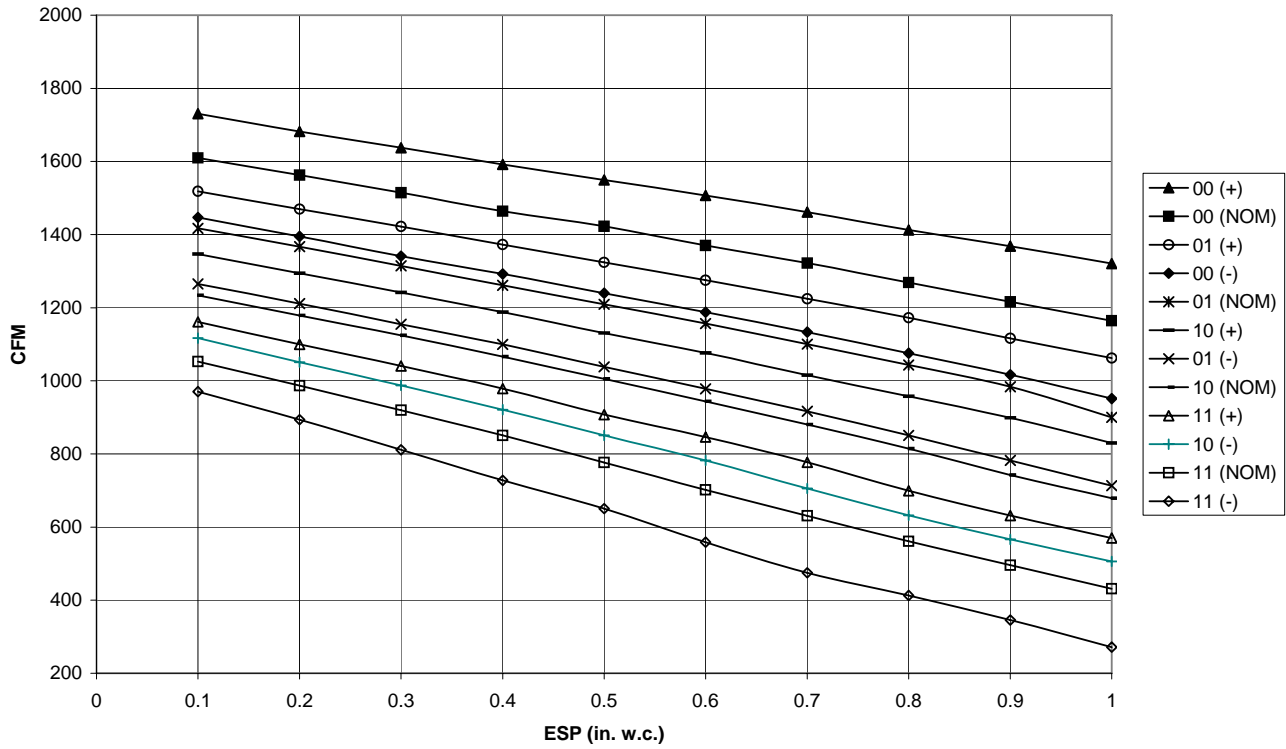

Low Cooling Airflows *8MPV075F14

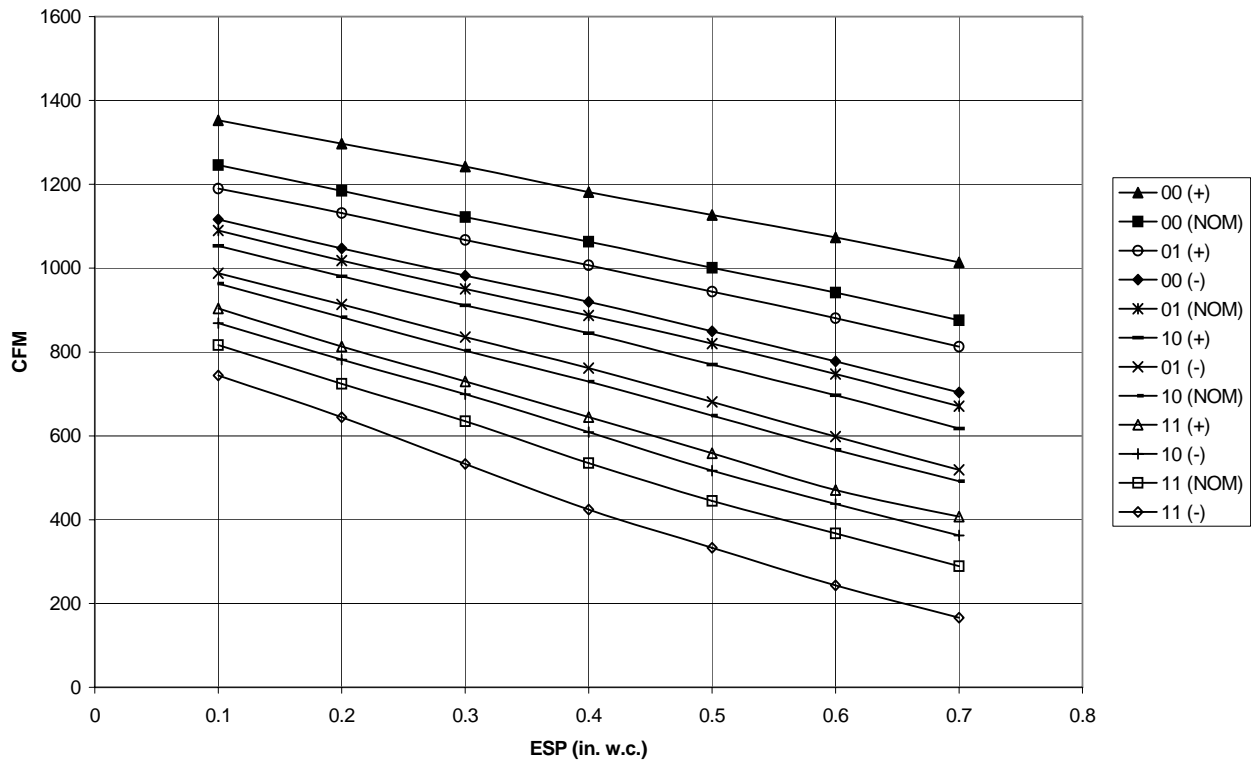

NOTE: OFF = 0 / ON = 1

Circulation Air Blower Data - *8MPV100

Cooling Adjustment					Heating Rise Adjustment			
DIP Switch (OFF = 0 ON = 1)	High Cool @ .50 in wc(125 Pa)		Low Cool (80% of High Cool)		** Adjust Jumper Setting	DIP Switch (OFF = 0 ON = 1)	High Heat Rise Change @ 0.20 in wc (50 Pa)	Low Heat Rise Change at Resultant Static
	5 & 6	CFM	L/s	CFM				
00	2101	992	1681	793	+	00	-3	-3
*00	2016	951	1613	761	*NOM	*00	0	0
00	1847	872	1478	697	-	00	4	4
01	1721	812	1377	650	+	01	5	6
01	1600	755	1280	604	NOM	01	9	9
01	1470	694	1176	555	-	01	15	16
10	1334	630	1067	504	+	10	2	2
10	1228	580	982	463	NOM	10	7	6
10	1114	526	891	420	-	10	11	11
11	920	434	736	347	+	11	-9	-9
11	809	382	647	305	NOM	11	-7	-6
11	698	329	558	263	-	11	-3	-3

Airflow performance includes 1" washable filter media.

*Factory Setting

**Adjust Jumper Setting (+, NOM, -) is applied to both Cooling and Heating

Note 1: HP Mode Jumper provides a 10% reduction in airflow when in Comfort position and a call for low or high cooling is present with the "O" line off. This feature is to provide lower airflow for running in HP Heating Mode if desirable.

Note 2: DEHUM mode (24VAC on DEHUM terminal) provides a 20% airflow reduction during cooling calls.

Note 3: Low Heat ESP is a result of High Heat ESP (- is decrease in rise).

Note 4: High and low heat rise values are approximate air temperature change from return air temperature when at factory default settings.

Table 2			Airflow	
DIP Switch (OFF = 0 / ON = 1)	Continuous Fan @ 0.10 in wc (25 Pa) ESP			
	1 & 2	CFM	L/s	
*00	1006	475		
01	1764	832		
10	2205	1041		
11	2205	1041		

Table 3		SW2 DIP Assignments	
DIP Switch	Blower Parameter		
1 & 2	Cont Fan Adj		
3 & 4	Heat Speed Adj		
5 & 6	Cool Speed Adj		
7 & 8	Cool On/Off Delay		

* Factory Setting

Table 4	Cooling Delay Options (SW2 - 7, 8)			
	ON DELAY		OFF DELAY	
	DIP SW2 - 7/8 (OFF = 0 / ON = 1)	Timed ON (sec)	Airflow during on delay	Timer OFF (sec)
*00	5	OFF	90	100%
01	5	OFF	0	OFF
10	30	50%	30	100%
11	30	50%	180	50%

Airflow % is of High Cool airflow demand determined from SW2-5/6 Table 1

Airflow resumes to 100% after on delay time is completed

Airflow stops (or switches to continuous fan speed) after off delay time is completed

* Factory Setting

MAX CFM (L/s) for Factory Washable Filters	
Filter Size in(mm)	CFM(L/s)
14" X 25" (356 x 635)	1400 (661)
16" X 25" (406 x 635)	1600 (755)
20" X 25" (508 x 635)	2000 (944)
24" X 25" (610 x 635)	2500 (1180)
Max CFM (L/s) based on 600 FPM (3.0 M/s)	

NOTE: Disposable filters are typically rated at 300 FPM (1.5 M/s). These filters only allow half the airflow when compared to 600 FPM (3.0 M/s) filters.

EXAMPLE (approx.):

20in X 25in @ 600 FPM = 2000 CFM, @ 300 FPM = 1000 CFM
508mm x 635mm @ 3.0 M/s = 944 L/s, @ 1.5 M/s = 472 L/s

Circulation Air Blower Data - *8MPV100

High Cooling Airflows *8MPV100J20

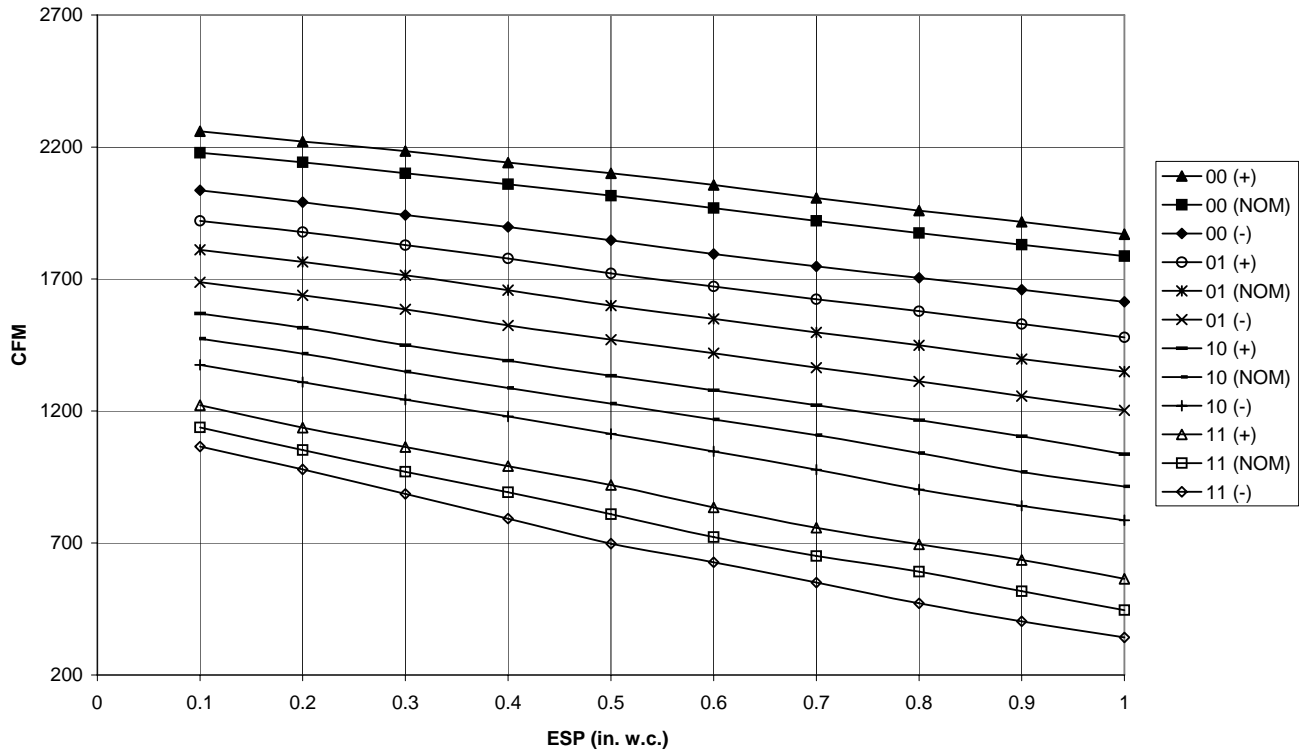

Low Cooling Airflows *8MPV100J20

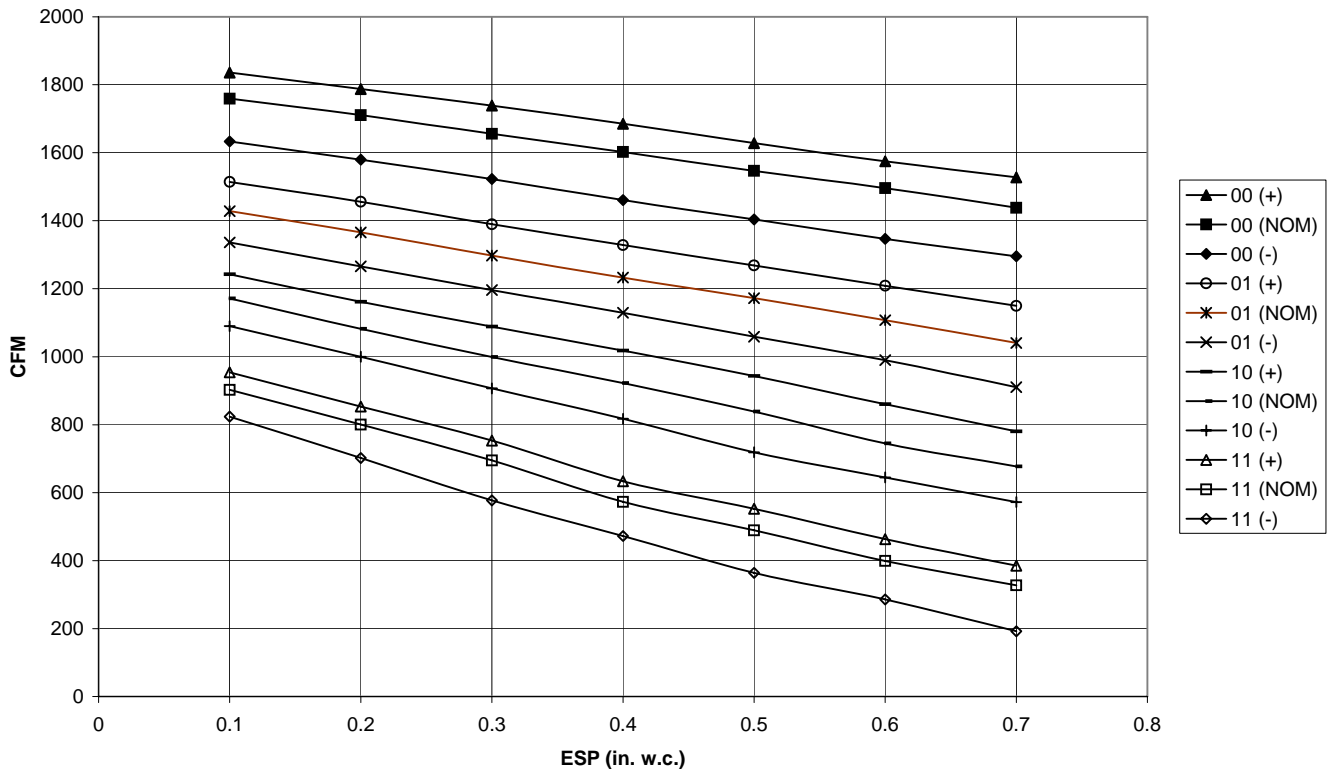

NOTE: OFF = 0 / ON = 1

Circulation Air Blower Data - *8MPV125

Cooling Adjustment					Heating Rise Adjustment			
DIP Switch (OFF = 0 ON = 1)	High Cool @ .50 in wc(125 Pa)		Low Cool (80% of High Cool)		** Adjust Jumper Setting	DIP Switch (OFF = 0 ON = 1)	High Heat Rise Change @ 0.20 in wc (50 Pa)	Low Heat Rise Change at Resultant Static
	5 & 6	CFM	L/s	CFM				
00	2153	1016	1722	813	+	00	-3	-3
*00	2001	944	1601	756	*NOM	*00	0	0
00	1808	853	1446	682	-	00	4	4
01	1761	931	1409	665	+	01	-1	0
01	1621	765	1297	612	NOM	01	4	3
01	1458	688	1166	550	-	01	8	8
10	1345	635	1076	508	+	10	-2	-1
10	1216	574	973	459	NOM	10	2	2
10	1074	507	859	405	-	10	7	5
11	933	440	746	352	+	11	-6	-4
11	802	378	642	303	NOM	11	-3	-2
11	692	327	554	261	-	11	1	1

Airflow performance includes 1" washable filter media.

*Factory Setting

**Adjust Jumper Setting (+, NOM, -) is applied to both Cooling and Heating

Note 1: HP Mode Jumper provides a 10% reduction in airflow when in Comfort position and a call for low or high cooling is present with the "O" line off. This feature is to provide lower airflow for running in HP Heating Mode if desirable.

Note 2: DEHUM mode (24VAC on DEHUM terminal) provides a 20% airflow reduction during cooling calls.

Note 3: Low Heat ESP is a result of High Heat ESP (- is decrease in rise).

Note 4: High and low heat rise values are approximate air temperature change from return air temperature when at factory default settings.

Table 2	Airflow	
DIP Switch (OFF = 0 / ON = 1)	Continuous Fan @ 0.10 in wc (25 Pa) ESP	
1 & 2	CFM	L/s
*00	1013	478
01	1674	790
10	2193	1035
11	2193	1035

Table 3	SW2 DIP Assignments
DIP Switch	Blower Parameter
1 & 2	Cont Fan Adj
3 & 4	Heat Speed Adj
5 & 6	Cool Speed Adj
7 & 8	Cool On/Off Delay

* Factory Setting

Table 4	Cooling Delay Options (SW2 - 7, 8)			
	ON DELAY		OFF DELAY	
DIP SW2 - 7/8 (OFF = 0 / ON = 1)	Timed ON (sec)	Airflow during on delay	Timer OFF (sec)	Airflow during off delay
*00	5	OFF	90	100%
01	5	OFF	0	OFF
10	30	50%	30	100%
11	30	50%	180	50%

Airflow % is of High Cool airflow demand determined from SW2-5/6 Table 1

Airflow resumes to 100% after on delay time is completed

Airflow stops (or switches to continuous fan speed) after off delay time is completed

* Factory Setting

MAX CFM (L/s) for Factory Washable Filters	
Filter Size in(mm)	CFM(L/s)
14" X 25" (356 x 635)	1400 (661)
16" X 25" (406 x 635)	1600 (755)
20" X 25" (508 x 635)	2000 (944)
24" X 25" (610 x 635)	2500 (1180)
Max CFM (L/s) based on 600 FPM (3.0 M/s)	

NOTE: Disposable filters are typically rated at 300 FPM (1.5 M/s). These filters only allow half the airflow when compared to 600 FPM (3.0 M/s) filters.

EXAMPLE (approx.):

20in X 25in @ 600 FPM = 2000 CFM, @ 300 FPM = 1000 CFM
508mm x 635mm @ 3.0 M/s = 944 L/s, @ 1.5 M/s = 472 L/s

Circulation Air Blower Data - *8MPV125

High Cooling Airflows
*8MPV125J20

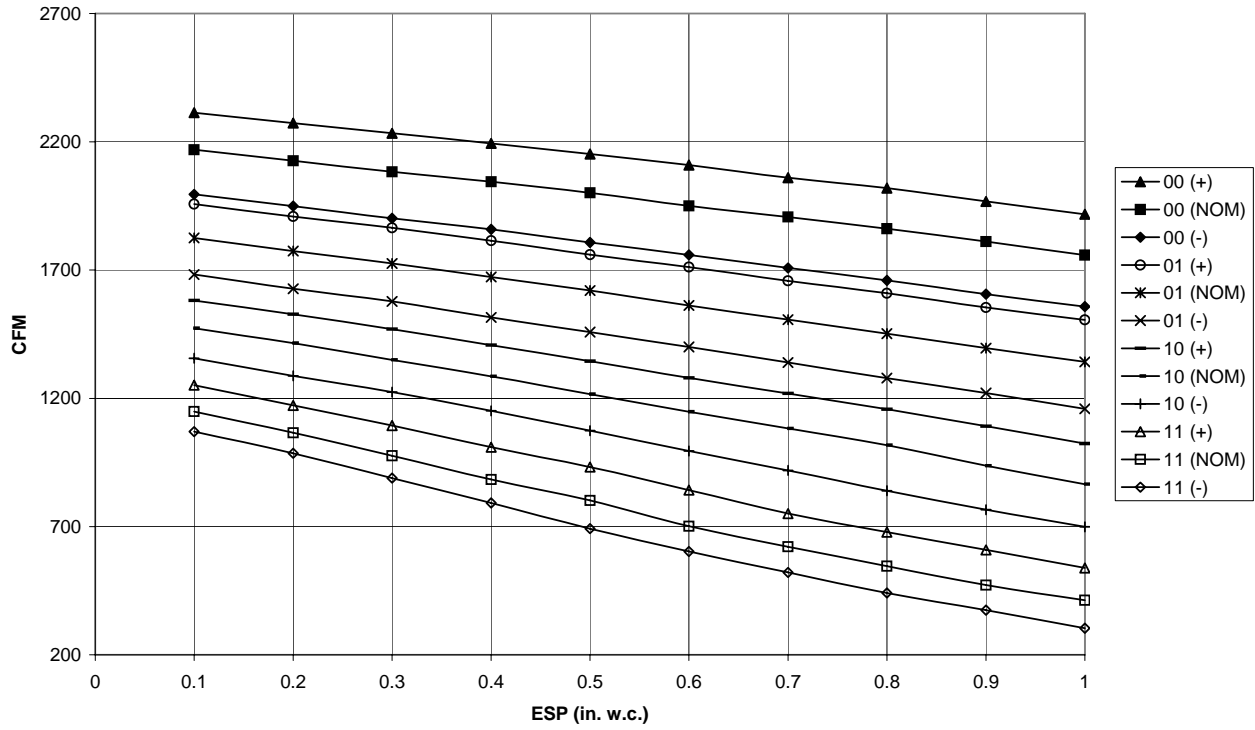

Low Cooling Airflows
*8MPV125J20

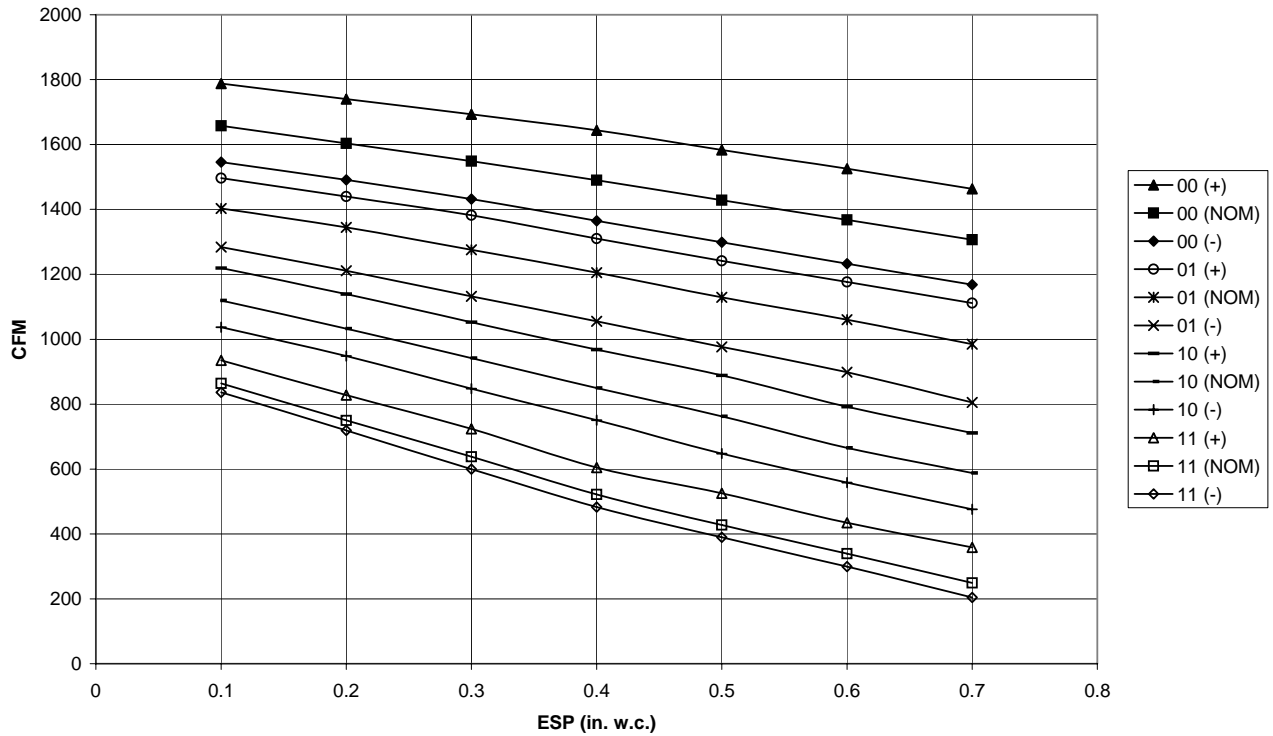

NOTE: OFF = 0 / ON = 1

Variable Speed (8MPV) Tap Select Interface Board (TSIB)

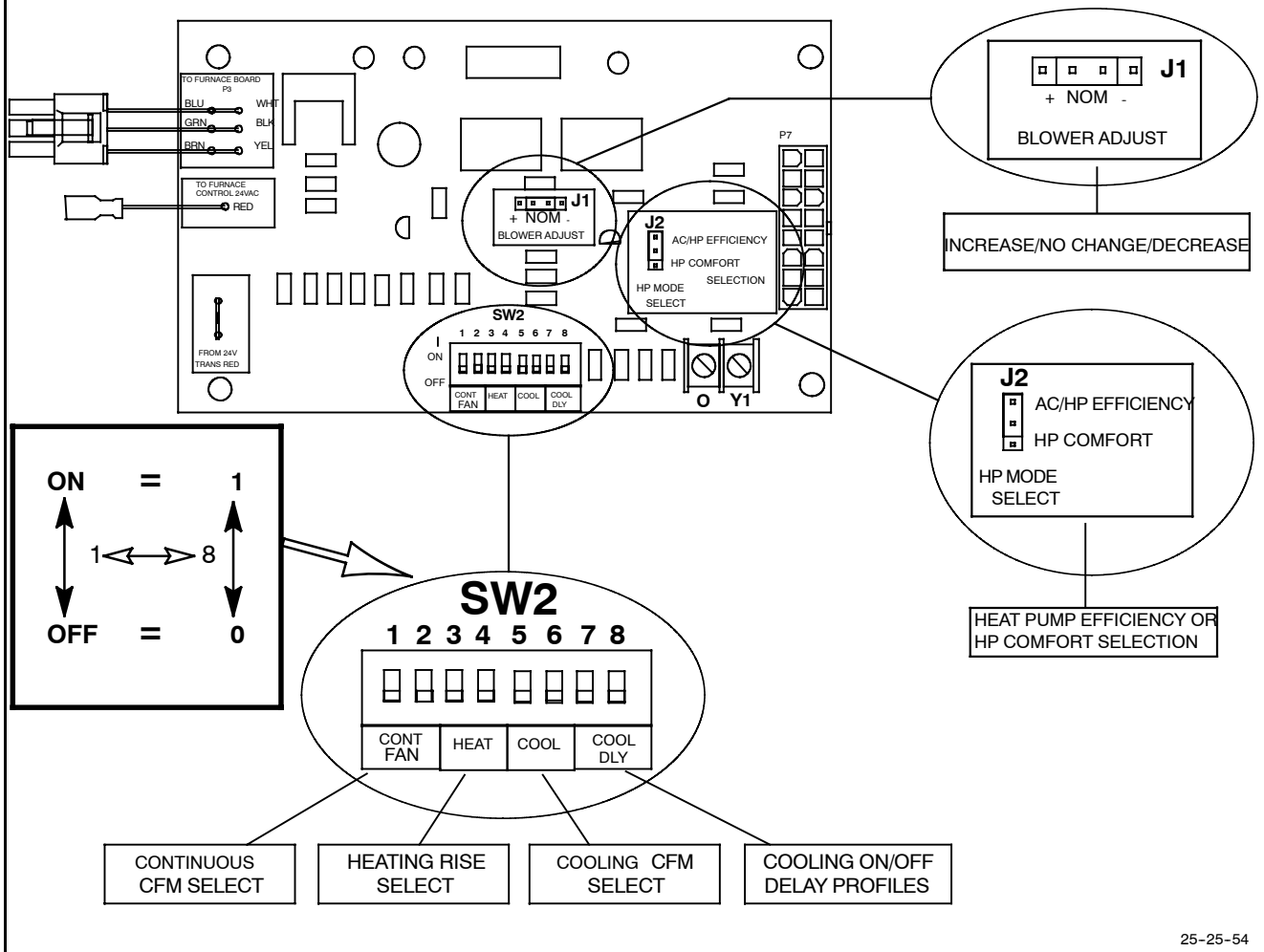

25-25-54

International Comfort Products, LLC
 Lewisburg, TN 37091 U.S.A.
 www.GoDayandNight.com